

The **Compact Series** of depositors are work horses and can be fitted with a full range of Unifiller accessories and attachments.

## COMPACT DEPOSITOR SERIES

Designed by Bakers for Bakers

The Compact is available in four options:

- Compact Table Top FS
- Compact Mobile FS
- Compact Power Lift FS
- Dual (two Compacts on one frame)

### Benefits:

- Small footprint
- Speed and portion accuracy
- Full wash down — all food contact parts dishwasher safe
- Tool free, quick cleaning and change-over design
- Deposit range — 0.3 oz (9 ml) – 18 oz (530 ml)

### Features:

- 5 product cylinder sizes available to meet your production requirements
- Stainless Steel design — Volumetric depositing
- Power Lift Model has a “one touch” system for raising and lowering of hopper
- The Mobile can be height adjusted manually
- Mobile and Power Lift have a 14 US Gallon conical hopper; Table Top has a 6 US Gallon conical hopper

### System includes:

- 2.5” product cylinder
- Removable depositing table
- Spout nozzle and foot pedal
- Quick start guide & spare parts kit

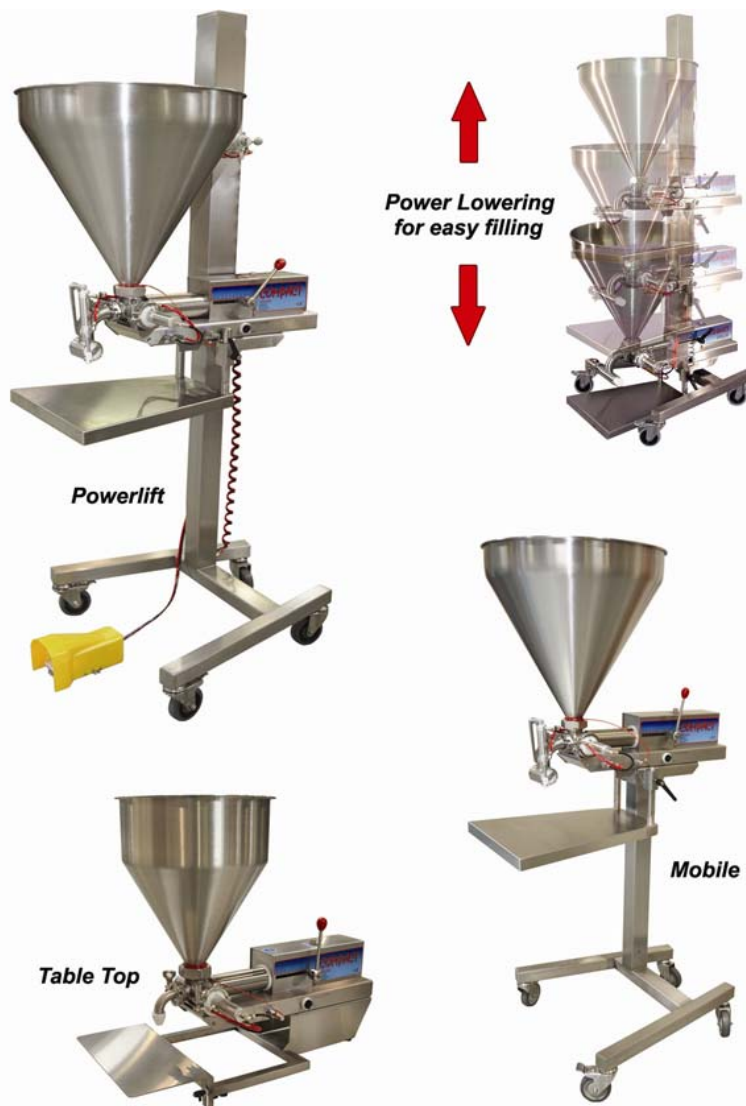

[Click Here to Watch Video](#)



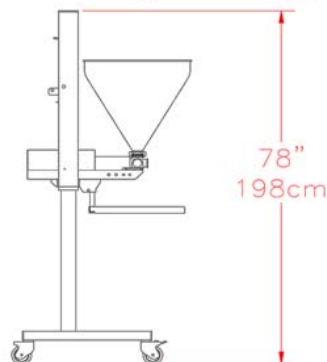
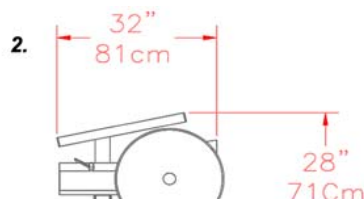
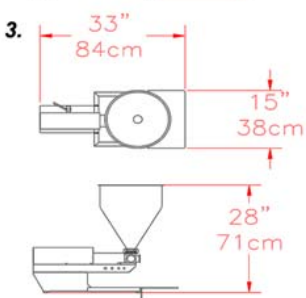
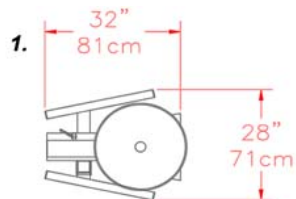

1. Compact Mobile  
2. Compact Powerlift  
3. Compact Table Top



Product Cylinder Size	DEPOSIT VOLUME (fl oz)			
	Min		Max	
3"	1.8 oz	(53 ml)	18 oz	(530 ml)
2.5"	1.2 oz	(35 ml)	12.3 oz	(360 ml)
2"	0.8 oz	(24 ml)	7.6 oz	(225 ml)
1.5"	0.5 oz	(15 ml)	4.0 oz	(120 ml)
1"	0.3 oz	(9 ml)	1.7 oz	(50 ml)

## Shipping Information





### Mobile / Power Lift:

- Dimensions: 36" x 30" x 52" (92cm x 76cm x 132cm)
- Weight: 200 lbs. (91kg)

### Table Top:

- Dimensions: 23" x 22" x 26" (58cm x 56cm x 66cm)
- Weight: 85 lbs (39kg)

## Performance Specifications

 <p><b>Speed</b> Up to 140 deposits/min (8400 deposits/hr) based on deposit size and consistency.</p>	 <p><b>Power</b> 3 – 5 CFM @ 80PSI 85-141.5 litres per minute @ 5.5 Bar.</p>
 <p><b>Volume</b> 0.3 oz to 18 oz. 9ml to 530ml</p>	 <p><b>Particle Size</b> Up to 3/4" cube 19mm</p>

**Note:** Equipment quoted is designed to run at the quoted speed and is dependent on operator efficiency, skill, and deposit size and product consistency.



45 Garema Circuit, Kingsgrove NSW 2208 Australia  
t. +61 2 9740 5122  
e. info@rvo.com.au  
www.rvo.com.au