

The **Border-Mate** was created to replace the conventional pastry bag with an almost effortless way of piping icings, frostings and decorations onto cakes.

### Benefits:

- Dramatically eliminates work related injury such as Carpal Tunnel Syndrome
- No Bags to fill — No Bags to squeeze!
- Allows an entry level operator to automatically produce consistent shell borders quickly
- Full wash down – all food contact parts dishwasher safe
- Tool free, quick cleaning and change-over design

### Features:

- Deco-Mate 3 equipped with Border-Mate controls
- Dial in decorations such as shell borders, ribbons and more

### System Includes:

- 1 hand bordering nozzle with food grade hose
- Hand nozzle balancer
- 10 gallon (38 liter) hopper and follower plate
- 7 small Standard Bakery Tips and 3 large Standard Bakery Tips
- Spare parts kit

## Border-Mate

Automated Shell Border Decoration!





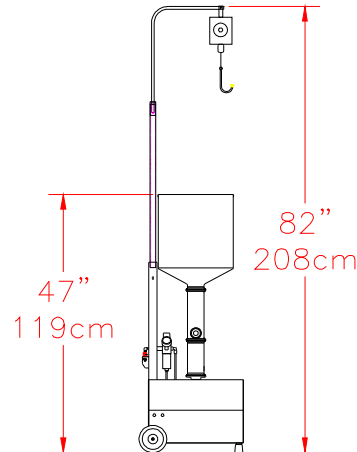
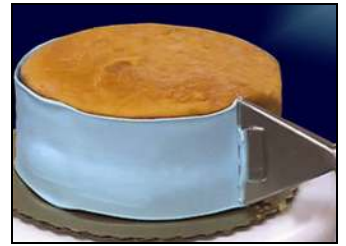
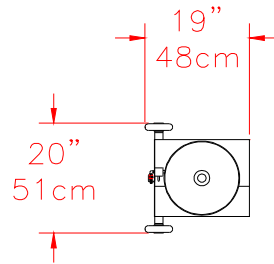

Easy to use controls





## Performance Specifications:

	<b>Speed</b> Operator Controlled		<b>Power</b> Air only 4 CFM @ 20-80 PSI 113 liters/minute @ 1.3-5.5 Bar
	<b>Volume</b> Up to 17fl. oz./stroke Up to 502ml/stroke		<b>Particulate Size</b> Smooth products only (no particulate)

## Shipping Information

- Dimensions: 21"x 21"x 38" (53cm x 53cm x 97cm)
- Weight: 90 lbs (41kg)

*Note: Equipment quoted is designed to run at the quoted speed and is dependent on operator efficiency, skill, and deposit size and product consistency.*