

edhard

Equipment and Accessory Guide

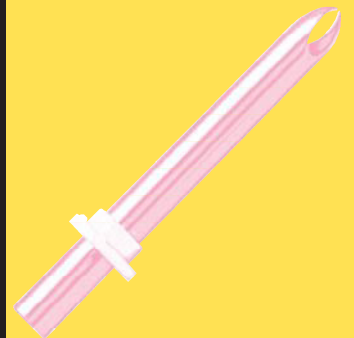
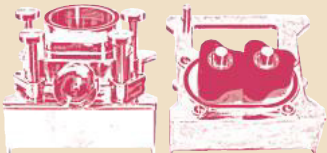
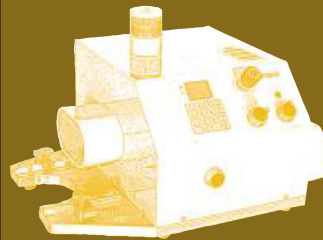
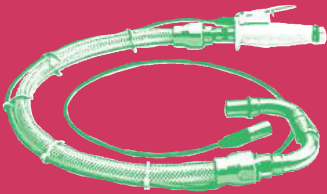
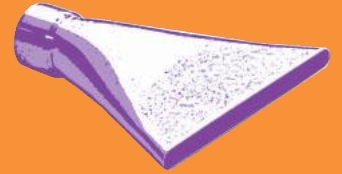
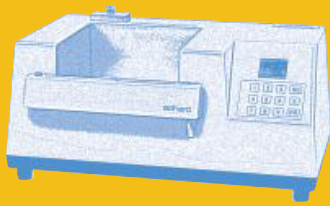

PT-SERIES

The Edhard PT-Series is a stand-alone system that can be used as a dosing pump and also as a transfer pump. Its reversible motor means that this system can be used with a suction tube (for looser products) as well as a gravity-fed hopper (just like our table-top units).

The system is comprised of four major components -

- ① **Power Base**
- ② **Pump**
- ③ **Cart**
- ④ **Suction Tube/Hopper**

Various Accessories are available to finish off the system - Batter Spouts, Elbows, Extensions, etc.

Remember, if you don't see what you had in mind chances are good that we can manufacture something to meet your specifications.

Please call or e-mail with any questions.

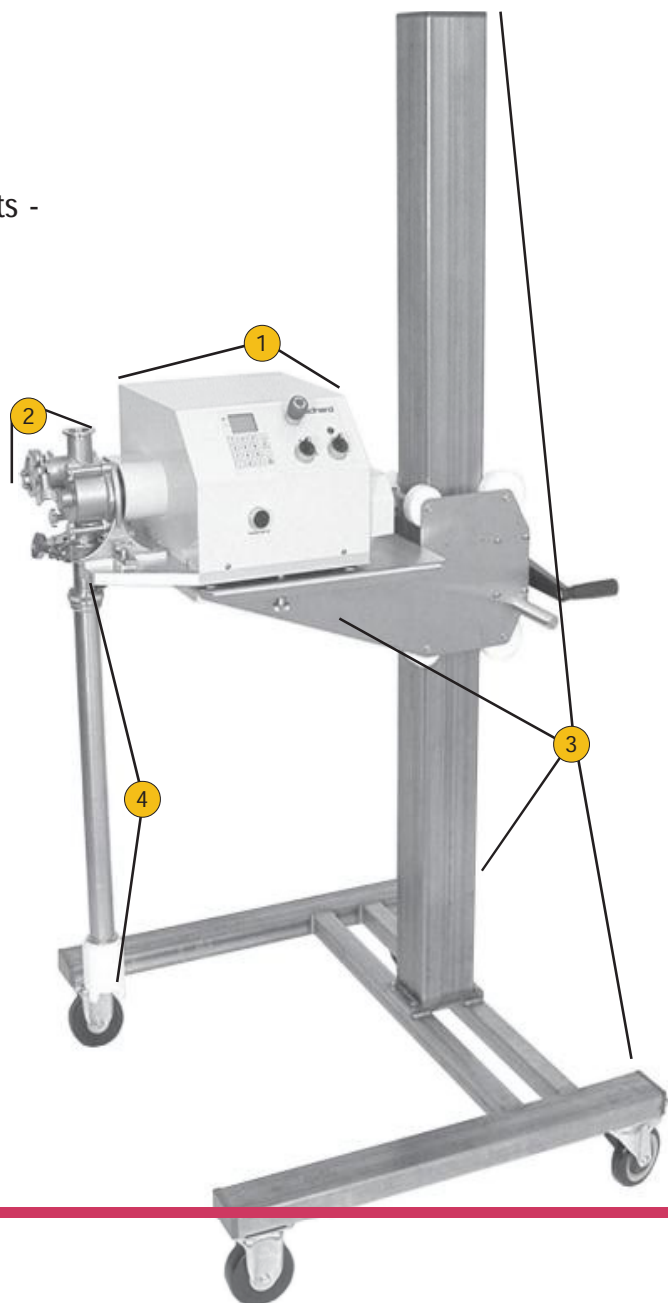

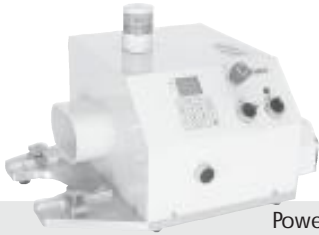

- PT-4035:** 200W motor 120VAC Model MKT
- PT-4036:** 200W motor 220VAC Model MKT
- PT-4037:** 400W motor 220VAC Model MKT

Power Base · Variable Speed · Transfer Type

What fits me?

P



Cart

- PT-8010:** Stainless Steel · for use with PT-Series Power Bases



Balancer Assembly

- PT-3381:** Used to counterbalance a Hose Assembly- attaches to column of PT-8010



P Pump · Suction · Stainless Steel

- FT-3342:** Gear-Type Stainless and Nylon Impellers
- FT-3465:** Gear-Type PEEK Impellers

What fits me?

A S



P Pump · Suction · Stainless Steel

- FTR-3343:** Lobe-Type Viton 3-Lobe Impellers

What fits me?

A S

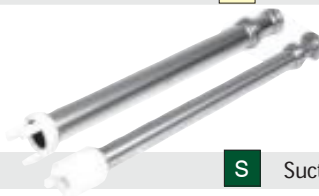

S Suction Tube

- FT-3375:** 1-1/4"Ø w/ ball check valve
- FT-3430:** 2"Ø w/out ball check valve



FT-3366: Gear-Type Stainless and Nylon Impellers
FT-3466: Gear-Type Stainless Impellers
FT-3470: Gear-Type PEEK Impellers - for Low-Viscosity products
FT-3573: Gear-Type PEEK Impellers - Single Outlet Housing

P Pump · Hopper Feed · Stainless Steel

What fits me?

A H



FTR-3371: Lobe-Type Viton 3-Lobe Impellers

P Pump · Hopper Feed · Stainless Steel

What fits me?

A H

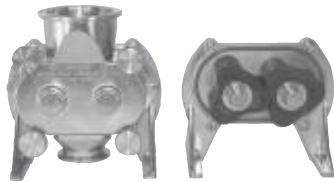

FT-3516: Lobe-Type Viton 3-Lobe Impellers · Single Outlet Housing

P Pump · Hopper Feed · Stainless Steel

What fits me?

A H



FT-20064: 18 Qt. (17L) capacity w/ 45° neck
FT-20065: 18 Qt. (17L) capacity w/ 30° neck
FT-20131: 36 Qt. (34L) capacity

H Hopper · Stainless Steel · for use on FT- and FTR-Series Pumps

What fits me?

J P



FT-3520: Manifold · Double · 4" (101.6mm) spacing - sanitary connections

A Adaptor

What fits me?

S A



FT-3399: Sanitary Fitting to 7/8" Ø (22.2mm) · used to mate Single Outlet Spouts to FT- or FTR-Series Pumps

A Adaptor

What fits me?

S



FT-20176: Hose to Sanitary Fitting · used to mate Hose Assy. to FT- or FTR-Series Pumps

A Adaptor

What fits me?

H



FT-3586: Connector · used to mate FT-Series Adaptors, Elbows, Batter & Cupcake spouts to FT- or FTR-Series Pumps

A Adaptor

What fits me?

S E



A Adaptor

FT-3377:
CUSTOM:

Universal Extension · 1-1/8"Ø x 18-1/2"L (28.6mm x 470mm)
Universal Extension · 1-1/8"Ø x Specify Length

What fits me?

S **E**



E Elbow · *Threaded Tip*

FT-3379:

Universal Extension to 7/8" Thread · 1-1/8"Ø - 7/8"Thread (28.6mm - 22.2mm)

What fits me?

T



E Elbow · *for use w/ F-Series Stainless Cupcake Spouts*

FT-3386:

Universal Extension to Cupcake Spout · 1-1/8"Ø - 7/8"Ø (28.6mm - 22.2mm)

What fits me?

C



E Elbow · *for use w/ FT-Series Stainless Cupcake Spouts*

FT-3378:

Universal Extension to Cupcake Spout · 1-1/8"Ø - 1-1/8"Ø (28.6mm - 28.6mm)

What fits me?

S



S Spout

FT-20217:

Batter



S Spout

FT-3395:

Double Batter



S Spout

FT-3376:
CUSTOM:

Dripless Cupcake · 3-1/4" (82.55) spacing
Dripless Cupcake · Specify spacing



- FT-3563:** Cupcake · 3/4"Ø x 3-1/4"Spacing (11.1mm x 82.55mm)
- FT-3570:** Cupcake · 7/8"Ø x 2-3/4"Spacing (22.2mm x 69.85mm)
- FT-3569:** Cupcake · 7/8"Ø x 3-1/4"Spacing (22.2mm x 82.55mm)
- FT-3568:** Cupcake · 7/8"Ø x 3-3/8"Spacing (22.2mm x 85.73mm)
- FT-3567:** Cupcake · 7/8"Ø x 3-5/8"Spacing (22.2mm x 92.08mm)
- FT-3566:** Cupcake · 7/8"Ø x 4"Spacing (22.2mm x 101.6mm)
- FT-3565:** Cupcake · 7/8"Ø x 4-1/8"Spacing (22.2mm x 104.78mm)
- FT-3571:** Cupcake · 7/8"Ø x 4-1/4"Spacing (22.2mm x 107.95mm)
- FT-3564:** Cupcake · 7/8"Ø x 4-3/8"Spacing (22.2mm x 111.13mm)
- CUSTOM:** Cupcake · Specify Spacing

S Spout · 3/4" or 7/8" Threaded Tip

What fits me?

T **T**



- FT-3402:** Hose Assy. · 7/8"Threaded Tip - 36"(914M) long
- CUSTOM:** Hose Assy. · 7/8"Threaded Tip - Specify Length

H Spout

What fits me?

D **T**



- FT-3548:** Hose Assy. · 7/8"Threaded Tip - 36"(914M) long w/ F-3141 Extension wand for use on FT- & FTR-Series Pumps
- CUSTOM:** Hose Assy. · 7/8"Threaded Tip - Specify Length

H Spout

What fits me?

S **T**



- FT-3617:** Bundt · 4x7/8"Ø on a 3-1/2"Ø (4x22.2mm x 88.9mm)
- CUSTOM:** Bundt · 4x7/8"Ø x Specify Diameter

S Spout · 7/8" Threaded Tip

What fits me?

T

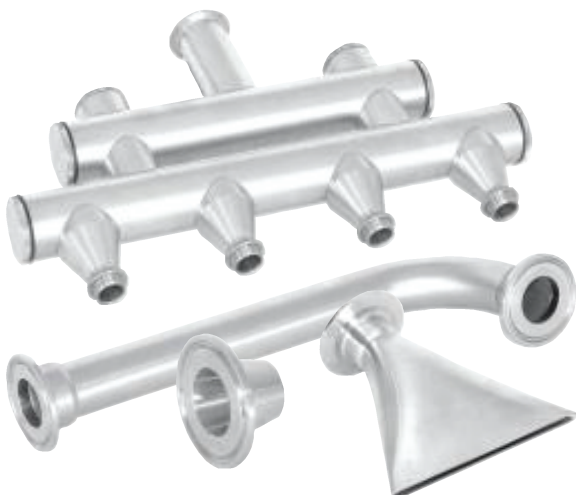

- CUSTOM:** Spouts/Extensions/Orifices · Specify product, application, size, etc.

A **E** **S** Custom



45 Garema Circuit, Kingsgrove NSW 2208 Australia
 t. +61 2 9740 5122
 e. info@rvo.com.au
 www.rvo.com.au