



▶ OVEN LINE

Roto Bravo rack oven for bread and pastry





POLIN

POLIN

Control panel with digital display and buttons.

Emergency stop button (red).



The compact rack oven, without compromise!

Bravo rack ovens range was born to satisfy the demand of matching high quality standards in production with reduced space.

Bravo rack ovens keep the construction features and technical standards of Polin rack ovens and are especially suitable for the production of bakery products and pastry products.

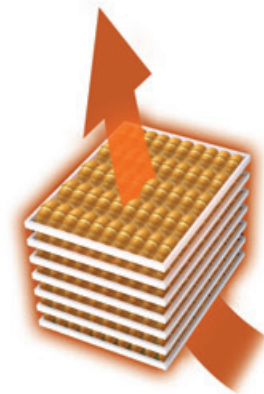

The special shape of the **air ducts and the baking air circuit** set the flux into an upward direction, giving excellent baking results and excellent product growth.

ROTO BRAVO

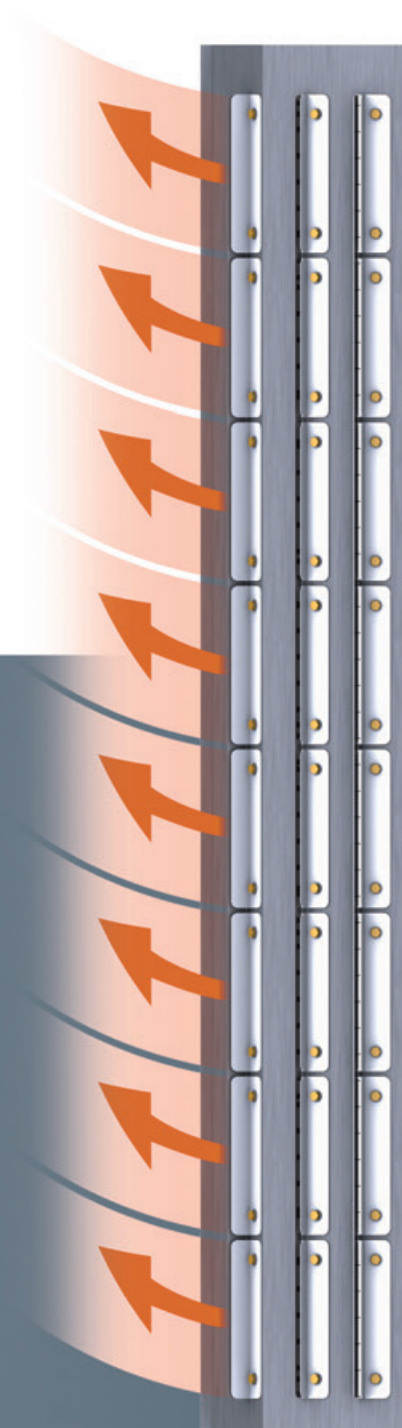



► FEATURES

Details with big difference

Combustion chamber is made with a big radiant surface, thanks to the big quantity of pipes and the peculiar shape of fumes circuit. This solution, together with thick refractory st/st structure, grants:

- high efficiency
- low consumption rates
- long-term durability

Door with **double closure** for steam tight seal.

The oven is preset for the installation of a semi-automatic **lever lifting device** to ease rack loading/unloading operations (optional).

Thermal insulation made of multiple layers of **high density pressed panels**.

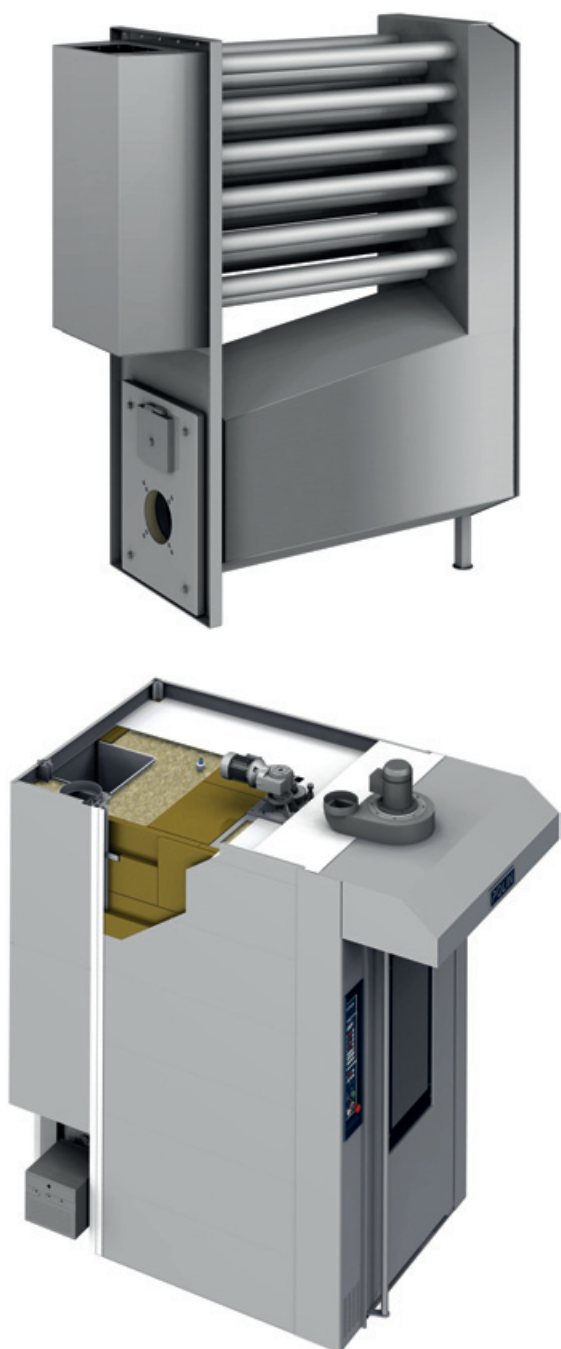

The perfection of the steamer ball

The steamer has a modular vaporiser unit with cascading elements, equipped with **balls** (large quantity and high quality of steam).

The balls placed in contact with the water vibrate, crumbling any formation of limestone, with a self-cleaning effect for the elements.

It is possible to install a larger steamer with dual water delivery to further increase the availability of steam and to increase the thermal mass. 



Automatic steam distribution system

The automatic steam distribution system managed by software, in combination with constant pressure baking, keeps the surface of the product moist for a long period of time.



Controlled measuring of the water to be vaporised

The litre counter measures the intake of water to be vaporised according to the quantities required by the program, independently of the pressure of water mains. 

Constant pressure baking for even better bread!

Roto Bravo is equipped with an innovative system that keeps the pressure inside the baking chamber constant. In addition to guaranteeing homogeneity and consistency in daily production, under any environmental condition, this also further improves product quality.

In fact, the flavoured and fragranced steam released by the baking bread is retained and constantly redistributed inside the oven.

Independent decompression duct inside the baking chamber to always grant the right pressure.



► COMPONENTS

Quality at your service

Extreme **feeding** versatility: methane, lgp, gasoil, electricity.

Double-glass window with compass opening system for easy cleaning. **1**

The **double stainless/silicon rubber seal** on the vertical and upper wells of the door guarantees a perfectly hermetic seal. **2**

The door with double-glass has a strong and ergonomic **exterior handle with double closure**, to grant a perfectly hermetic seal, and an **interior safety handle**.

The **rack hooking device** is made entirely out of a casting with rounded profile and large cross section (platform optional, for racks with height up to 1940 mm). **3**

The **smooth floor** makes it easy to clean inside and make the entrance of the rack easier. **4**

Compact size for more versatility.



► OPTIONAL

- Stainless steel **side panels** **5**
- **Automatic vapor exhaust dumper** for easier and even bakings
- **Stronger electric group** to further increase productivity
- **Stronger steam generator** to further increase steam output
- **Burner on the right**
- **Low emitting glass**
- **Rack platform**

▶ KEYBOARD



	100P	200P	POLIN TOUCH
Baking programs	100	200	300
Phases for each baking cycle	12	6	10
Display	GRAPHIC LCD 8 rows 128X64	GRAPHIC LCD 4,8" 320x240	TOUCH SCREEN 7" 800x480
Password protected recipes	✓	✓	✓
Energy stand-by	✓	✓	✓
Temperature/time limiter	✓	✓	✓
Automatic system steam distribution	✓	✓	✓
Automatic start up	✓	✓	✓
Alarms to display malfunctions	✓	✓	✓
Function energy saving	⊘	✓	✓
Double air speed	⊘	✓	✓
Liter meter	⊘	✓	✓
Digital reserve keyboard	⊘	✓	✓
Automatic steam exhaust valve	⊘	✓	✓
Key for saving programs	⊘	⊘	✓
Motorized vapor exhaust valve	⊘	⊘	⊘
Time/temperature display	⊘	⊘	⊘
Program PC-network control of multiple ovens	-	⊘	✓

► DIMENSIONS

BRAVO 6080

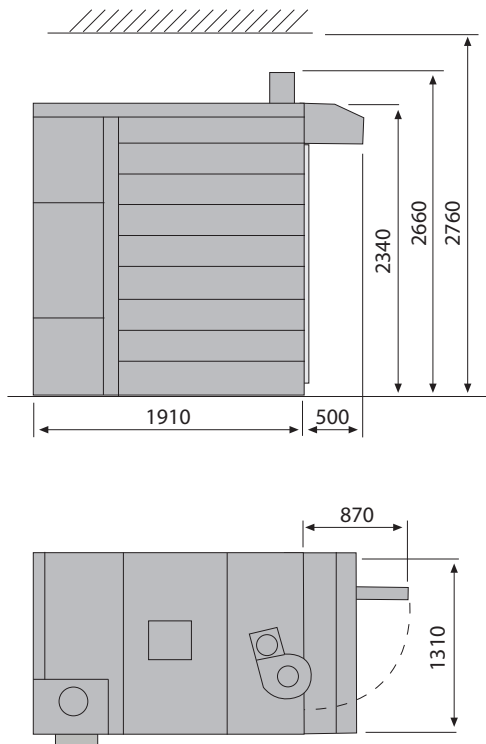

BRAVO 80100

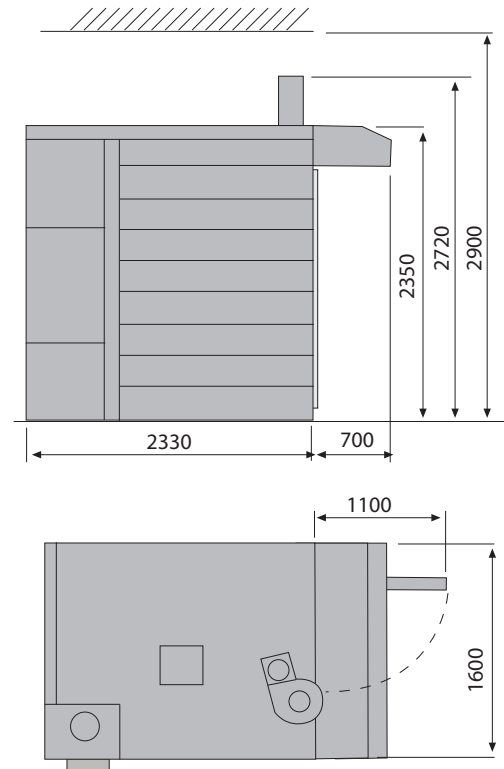

	Pan capacity		Pan dimensions	Weight	Electric power	Supply electric power	Power supply line	Burner capacity
	n°	pitch mm	mm	kg	kW	kW	V/~ /Hz	kcal/h
BRAVO 6080	16 18	105 93	600x800 n°2 600x400	1300	48,8+2,0	58,5+2,0	400/3N~/50	60.000
BRAVO 80100	16 18	105 93	800x1000	1650	63+2,8	-	400/3N~/50	80.000



Pictures, measurements and technical data are non-binding and thus subject to modification with no advance notice.



45 Garema Circuit, Kingsgrove NSW 2208 Australia
 t. +61 2 9740 5122
 e. info@rvo.com.au
 www.rvo.com.au